

 **texi**[®]

Culture of Sewing

Jak sprawdzić cenę produktu?



Zeskanuj kod QR
na swoim telefonie



CENA I INFO
www.strima.com/s1029



Wpisz link
w przeglądarce
internetowej

TEXI DRESS FORM 36-42 

Wpisz kod produktu
w wyszukiwarce na
www.strima.com

 **texi** Dress form

TEXI DRESS FORM 36-42

TEXI DRESS FORM 42-48

Zakres regulacji	36 - 42	42 - 48
obwód szyi	35 - 46 cm	35 - 46 cm
obwód biustu	84 - 100 cm	101 - 117 cm
obwód talii	64 - 80 cm	77 - 97 cm
obwód bioder	86 - 102 cm	102 - 119 cm



KROJENIE	4
PRZEMYSŁOWE MASZYNY DO SZYCIA	8
SPECJALISTYCZNE MASZYNY	32
AKCESORIA DO MASZYN PRZEMYSŁOWYCH	34
IGŁY DO MASZYN PRZEMYSŁOWYCH	40
IGŁY DO MASZYN DOMOWYCH	42
DOMOWE MASZYNY DO SZYCIA	48
AKCESORIA DO MASZYN DOMOWYCH	66
PATCHWORK	82
PRASOWANIE	86
ETYKIETOWANIE	92

Uczyniliśmy wszystko, aby informacje zawarte w tym prospekcie były najbardziej precyzyjne i aktualne. Zgodnie z naszą strategią stałego rozwoju produktów zastrzegamy sobie prawo modyfikowania ich elementów lub zmiany parametrów technicznych bez uprzedzenia. Żadna część tej publikacji nie może być powielana w jakiegokolwiek formie bez pisemnej zgody wydawcy. Prospekt ma charakter informacyjny i nie stanowi oferty handlowej. © Strima Sp. z o.o. Wszelkie prawa zastrzeżone. Wydrukowano w Polsce - kwiecień 2023.

texi Titanium Nożyczki



CENA I INFO

www.strima.com/s1014

- ✓ Powierzchnia ostrzy utwardzona tytanem
- ✓ Maksymalna odporność
- ✓ Dożywotnia gwarancja
- ✓ Miękki uchwyt



TI700

Nożyczki krawieckie 7" (18 cm) z tytanowanymi ostrzami



TI914

Nożyce krawieckie 9 1/4" (23,5 cm) z tytanowanymi ostrzami



TI613 CRAFT

Nożyczki tapicerskie 6 1/3" (16 cm) z tytanowanymi ostrzami



TI514

Nożyczki hafciarskie hobbystyczno - rzemieślnicze 5 1/4" (13 cm) z tytanowanymi ostrzami



TI814

Nożyce krawieckie 8 1/4" (21 cm) z tytanowanymi ostrzami



TIDUO850

Ti 514 + Ti 814
Zestaw: nożyce krawieckie 8 1/4" (21 cm) + nożyczki hobbystyczno - rzemieślnicze 5 1/4" (13 cm)

texi Titanium

OBEJRZYJ FILM O NOŻYCKACH



texi Titanium



miękki uchwyt



KROJENIE



TEXI ZORRO 100

Noż tarczowy z silnikiem AC Servo



27 MM



- średnica ostrza 100 mm
- bezobsługowy silnik AC Servo
- 5-stopniowa regulacja prędkości: 800, 950, 1100, 1250, 1400
- wysokość cięcia 27 mm
- lampa LED
- cicha praca
- lekki 1,3 kg



oświetlenie LED pola cięcia



CENA I INFO
www.strima.com/i45b1

TEXI ZORRO 110 FREE

Nóż tarczowy **bezprzewodowy** z silnikiem DC Servo



KROJENIE

32 MM



































- średnica ostrza 110 mm
- bezobsługowy silnik DC Servo
- 5-stopniowa regulacja prędkości: 800, 950, 1100, 1250, 1400
- wysokość cięcia 32 mm
- lampa LED
- cicha praca
- lekki 1,5 kg

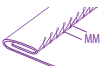

3 stopniowe oświetlenie LED pola cięcia LED

Ikony maszyn do szycia *texi*

AUTO		AUTOMATYCZNE OBCINANIE NICI		TRANSPORT DOLNY, GÓRNY ROLKOWY I IGŁOWY
		AUTOMATYCZNE RYGLOWANIE		SYSTEM IGIEŁ
		ODRZUTNIK NICI		ROZSTAW IGIEŁ
		AUTOMATYCZNE PODNOŻENIE STOPKI		WYŁĄCZANIE IGŁY
		AUTOMATYCZNE POZYCJONOWANIE IGŁY		WYSOKOŚĆ PODNOŻENIA STOPKI
		KONTROLER ŚCIEGU POCZĄTKOWEGO		OŚWIETLENIE POLA PRACY
	TRANSPORT DOLNY		GRUBOŚĆ SZYTEGO MATERIAŁU	
	TRANSPORT IGŁOWY		PRĘDKOŚĆ SZYCIA	
	TRANSPORT DOLNY Z KROCZĄCĄ STOPKĄ		RODZAJ SILNIKA	
	POTRÓJNY TRANSPORT		LICZBA NICI	
	TRANSPORT RÓŻNICOWY			

	DŁUGOŚĆ ŚCIEGU
	
	
	
	
	
STANDARD	SZEROKOŚĆ ŚCIEGU
	
ZE WZMOCNIENIEM	
	
	
	LICZBA WZORÓW
	

	ROZMIAR DZIURKI DO GUZIKA
	ROZMIAR KLAMRY
	ROZMIAR NOŻA
	SYSTEM WIELOKROTNEGO CIĘCIA
	ROZMIAR RYGLOWANIA
	ŚREDNICA GUZIKA
	PRZYSZYWANIE GUZIKÓW NA SŁUPKU
	POLE PRACY
	PRZESKOK ŚCIEGU (INTERWAŁ)
	WYSOKOŚĆ SŁUPKA
	OBWÓD SŁUPKA

texi Stebnówki mechatroniczne 1-igłowe



TEXI TRONIC 6 NEO

Automatyczna stebnówka z transportem dolnym



TRANSPORT DOLNY



CENA I INFO

www.strima.com/i4Tby

	AUTO						
TEXI ART AUTO 2	✓	✓	-	✓	✓	✓	✓
TEXI TRONIC 3 NEO	✓	-	-	-	✓	-	✓
TEXI TRONIC 6 NEO	✓	✓	-	✓	✓	✓	✓
TEXI TRONIC 7 NF	✓	✓	✓	✓	✓	-	-

TEXI TRONIC 7 NF

Automatyczna stebnowka z transportem igłowym



CENA I INFO

www.strima.com/i4Np5



TRANSPORT IGŁOWY



TEXI TRONIC 3 NEO

Stebnowka z automatycznym obcinaniem nici i transportem dolnym



CENA I INFO

www.strima.com/i4UM1



TRANSPORT DOLNY



więcej str. 24 - 25



TEXI ART AUTO 2 PREMIUM

Stebnowka automatyczna ze ścięciem dekoracyjnym do lekkich i średnich materiałów, z wbudowanym silnikiem krokowym i sterowaniem

-	135 x 5	5	13	✓	L/M	5 000	550 W
-	135 x 5	5	13	✓	L/M	5 000	550 W
-	135 x 5	5	13	✓	L/M	5 000	550 W
✓	135 x 5	4	13	✓	L/M	4 000	550 W

texi Stebnówka mechatroniczna 2-igłowa

TEXI TWIN MS

Stebnówka 2-igłowa z transportem igłowym i automatycznym pozycjonowaniem igły



CENA I INFO

www.strima.com/i4N3U



TRANSPORT IGŁOWY



2-IGŁOWA



AUTO

-	-	-	-	PREMIUM EX	✓	135 x 5	6.4	✓	5	11	✓	L/M	3 000	550 W



PREMIUM

365

1 rok
gwarancji

najlepsza cena



PREMIUM EX

730









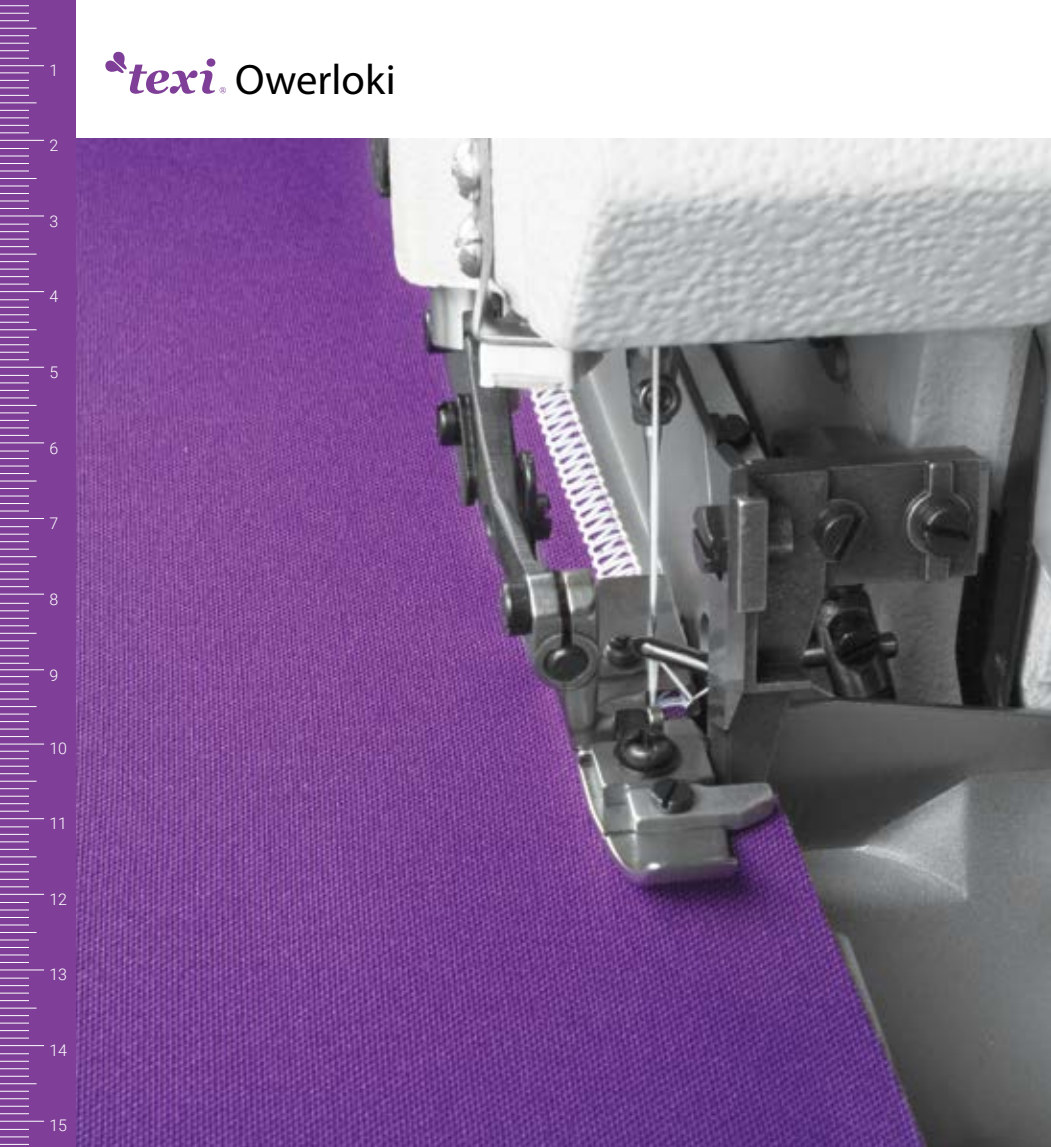

2 lata
gwarancji

dotatkowe
wyposażenie
w standardzie



WYDŁUŻONA GWARANCJA
NA MASZYNY PRZEMYSŁOWE
+ EKSTRA GRATISY



		AUTO								
										
16	TEXI TRE 04 N	-	-	-	-	✓	✓	1	B-27	-
17	TEXI QUATTRO 24 N	-	-	-	-	✓	✓	2	B-27	2
18	TEXI CINQUE 35 N	-	-	-	-	✓	✓	2	B-27	3

TEXI QUATTRO 24 N

Overlok mechaniczny
4-nitkowy



CENA I INFO
www.strima.com/i4Tc0

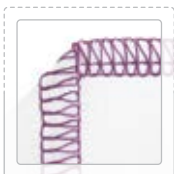

TEXI TRE 04 N

Overlok mechaniczny 3-nitkowy



CENA I INFO
www.strima.com/i4Tc4



TEXI CINQUE 35 N

Overlok mechaniczny 5-nitkowy











CENA I INFO
www.strima.com/i4Tc2



				 MM				 AC SERVO 230 V
3	4 mm	-	4 mm	6	✓	L/M	7 000	550 W
4	6 mm	-	4 mm	6	✓	L/M	7 000	550 W
5	5 mm	8 mm	4 mm	6	✓	L/M	7 000	550 W



	AUTO						
							
TEXI TRECCIA N	-	-	-	-	✓	1:0.5 ~ 1:1.3	3
TEXI TRECCIA C MATIC	✓	-	✓	✓	✓	1:0.5 ~ 1:1.3	3

TEXI TRECCIA N

Interlok 3-igłowy o płaskim łożu



CENA I INFO
www.strima.com/i4VJ5



PŁASKIE ŁOŻE



TEXI TRECCIA C MATIC

Interlok 3-igłowy o cylindrycznym łożu



CENA I INFO
www.strima.com/i4N3a



CYLINDRYCZNE ŁOŻE



SYSTEM	5.6 / 6.4	5	1.6 ~ 4.2 mm	6 MM	✓	-	6 000	AC SERVO 230V
UY 128 GAS	5.6 / 6.4	5	1.6 ~ 4.2 mm	6	✓	-	6 000	550 W
UY 128 GAS	5.6 / 6.4	5	1.6 ~ 4.2 mm	6	✓	✓	6 000	550 W

texi. Specjalistyczne maszyny do szycia

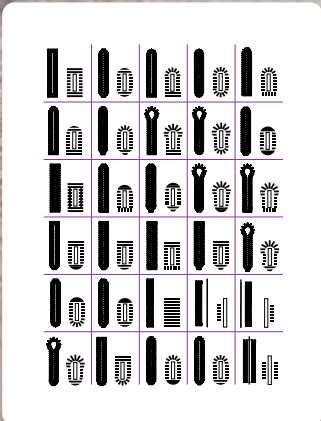

TEXI O NEO

Dziurkarka białoznana elektroniczna



CENA I INFO

www.strima.com/i4VwF



AUTO					SYSTEM	PATTERNS	A	A	MULTI CUT	MM	MM	MM	MM	MM	MM	MM	MM
✓	-	-	✓	-	135 x 5	30	A = 9.4 - 38.0 B = 6.4 - 31.8	A = 29, B = 5 A = 40, B = 6	✓	14	✓	L/M	3 600	550 W	AC SERVO 230 V		

TEXI 781 SERVO

Dziurkarka bielizniana



CENA I INFO

www.strima.com/i4MyU



AUTO

✓	-	-	-	-	135 x 5	30 x 6	A = 6.4 - 25.4 B = 2.5 - 5	6.4 - 19.1	12	✓	L/M	3 600	550 W	AC SERVO 230V		
							A = 6.4 - 31.8 B = 2.5 - 5	6.4 - 31								

TEXI CATENACCIO 2.0

Ryglówka elektroniczna



CENA I INFO

www.strima.com/i4Tbw

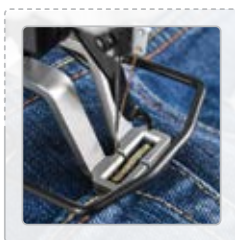

AUTO

✓	-	✓	✓	-	135 x 5	A=20 B=4.5	A=18 B=4	15 (100)	16	✓	L/M/H	3 000	550 W	AC SERVO 230V		

TEXI X

Dziurkarka elektroniczna



CENA I INFO
www.strima.com/i4N3d



WZORY Z CYKLU



8, 16, 32



AUTO



SYSTEM



MM



Ø = 10~28



A: 2.5 - 6.5



kolba



1 500



AC SERVO
230V

550 W

TEXI ZIGGY

Zygzak elektroniczny z funkcjami automatycznymi



CENA I INFO

www.strima.com/14N3b



PODSTAWOWE SCIEGI



AUTO

✓	✓	✓	✓	✓	135 x 5	29	114	5.0	10.0	6	✓	L/M	5000	550 W

PRZEMYSŁOWE MASZYNY DO SZYCIA

TEXI ACCURA

Podszycarka do ściegu jednostronnie krytego, do cienkich i średnich materiałów



CENA I INFO
www.strima.com/i4N3g



TEXI COMPACTA

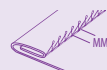

3.0 - 8.0



INTERVAL

1:1/1:2

TEXI ACCURA

3.0 - 8.0

1:1/1:2

TEXI COMPACTA

Przeñoalna podszywarka do ściegu jednostronnie krytego, do cienkich i średnich materiałów



MASZYNA
PRZEÑOŠNA



SYSTEM



AC SERVO
230 V

2140 TP

1 200

90 W

2140 TP

2 500

550 W



CENA I INFO
www.strima.com/14N3f

Stebnówka z automatyką

TEXITRONIC 3 NEO

Stebnówka z automatycznym obcinaniem nici



Płyta stołu PREMIUM

Odporność

Płyta stołu (30 warstw sklejki brzozonej) pokryta laminatem odpornym na uderzenia, odpryski, ścieranie, oddziaływanie oleju oraz wilgoć.



Solidna podstawa

Stabilność

Stabilne i trwałe podstawy Kessler z regulowaną wysokością



CENA I INFO
www.strima.com/i4UM1



w najlepszej cenie na rynku



Lampka LED
Lepszy widok

Zawsze warto
widzieć więcej



AC SERVO MOTOR
Oszczędności

Oszczędzasz do 70% energii









PRZEMYSŁOWE MASZYNY DO SZYCIA

texi Seria Walker

Stebnówki tapicerskie i kaletnicze do szycia grubych materiałów



	AUTO				
					
TEXI WALKER WF SERVO	-	-	-	-	✓
TEXI WALKER WF AUT	✓	✓	✓	✓	✓

TEXI WALKER WF SERVO

Stebnówka tapicerska i kaletnicza



CENA I INFO
www.strima.com/i451q

TEXI WALKER WF AUT

Automatyczna stebnówka tapicerska i kaletnicza











AUTO



CENA I INFO
www.strima.com/i451o



MASZYNY DO CIĘŻKIEGO SZYCIA

	 SYSTEM	 MM	 CM	 MM				 AC SERVO 230 V
✓	135 x 17	8	33,5	16	✓	M/H	2 000	550 W
✓	135 x 17	8	33,5	16	✓	M/H	2 000	550 W

texi^{HD} Seria HD

Stebnówki, lamowarki tapicerskie i kaletnicze - bardzo grube szycie

TEXI HD FORTE UF

Stebnówka tapicerska,
kaletnicza z potrójnym
transportem



CENA I INFO
www.strima.com/i4N3Q



POTRÓJNY TRANSPORT



	AUTO					
TEXI HD FORTE UF	-	-	-	-	✓	✓
TEXI HD FORTE-B UF	-	-	-	-	✓	✓
TEXI HD FORTE CILINDRO UF	-	-	-	-	✓	✓
TEXI HD FORTE CILINDRO-B UF	-	-	-	-	✓	✓

TEXI HD FORTE-B UF

Stebnowka tapicerska, kaletnicza z funkcją lamowania



CENA I INFO

www.strima.com/i4Nkf



POTRÓJNY TRANSPORT



TEXI HD FORTE CILINDRO UF

Stebnowka z cylindrczna, tapicerska, kaletnicza



CENA I INFO

www.strima.com/i4N3R



POTRÓJNY TRANSPORT



TEXI HD FORTE CILINDRO-B UF

Stebnowka z cylindrczna, tapicerska, kaletnicza z funkcją lamowania



CENA I INFO







www.strima.com/i4N3S



POTRÓJNY TRANSPORT



MASZYNY DO CIĘŻKIEGO SZYCIA

 SYSTEM	 CM	 MM	 MM		 AC SERVO 230 V	 CYLINDER-BED	 BINDING
134 - 35	26	8	14	2 800	750 W	-	-
134 - 35	26	8	14	2 800	750 W	-	✓
134 - 35	26	6	14	2 800	750 W	✓	-
134 - 35	26	6	14	2 800	750 W	✓	✓

TEXI POST DD PREMIUM

Stebnówka słupkowa
z transportem dolnym i górnym
rolkowym oraz igłowym



CENA I INFO
www.strima.com/i4NxX



AUTO



SYSTEM

CM

CM

MM

MM

✓

M/H

3 000

750 W

TEXI SEP SYSTEM

Maszyna wielofunkcyjna do szycia, haftowania i perforowania materiałów powlekanych i skór



CENA I INFO
www.strima.com/i4Twd



TEXI 1501 TS PREMIUM

Hafciarka przemysłowa **15-igłowa**

- Pole haftu 540 x 350 mm
- Prędkość szycia 1 200 (ścigów / minutę)
- Ekran dotykowy True-Color 7" LCD
- 13 tamborków
- Cylindryczne ramię
- Czapki, haft płaski i inne



CENA I INFO
www.strima.com/i4NxV

16
17
18
19
texi Prasy termiczne



Płaska 38 x 38 cm

TEXI HP-1515F-T



Płaska 40 x 50 cm

TEXI HP-1620F-T

Szkolenie z obsługi
i dostawa w cenie

TEXI IRIS 10

Kompaktowa hałciarka **10-igłowa**

- Pole haftu 310 x 210 mm
- Prędkość szycia
1 000 (ściągów / minutę)
- Ekran dotykowy True-Color 7" LCD
- 4 tamborki
- Cylindryczne ramię
- Czapki, haft płaski i inne

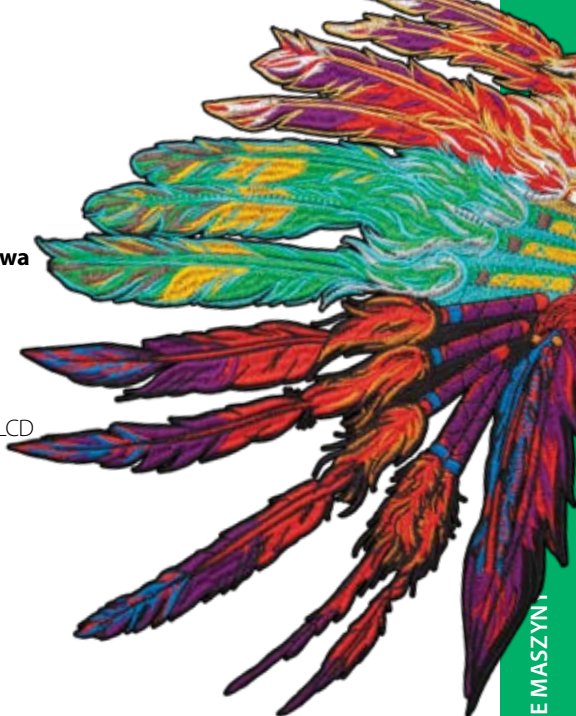

CENA I INFO
www.strima.com/i40Jc



Do czapek

TEXI HP-0306FC



Do kubków

TEXI HP-1112HM



CENA I INFO
www.strima.com/i80yw





HIT!

TEXI 4003

Trzpień do szybkiego
wymieniania stopek



CENA I INFO
www.strima.com/14LaY

TEXI 3 FEET

Głowica rewolwerowa
na 3 stopki
do stebnowki



CENA I INFO

www.strima.com/i4TmZ

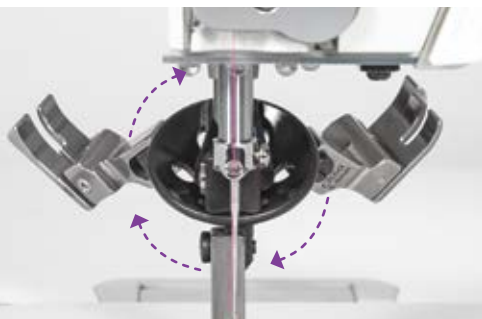

TEXI 4026

Obcinacz nitki do
maszyn przemysłowych,
stebnowek



CENA I INFO

www.strima.com/i4Law

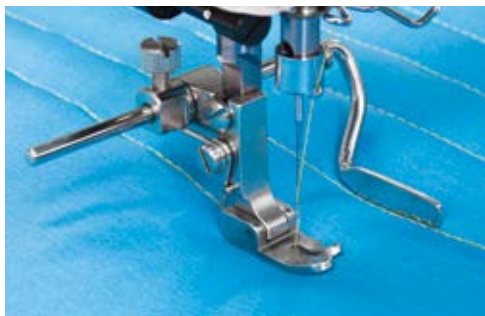

TEXI 5001

Stopka do szycia skór
i trudnych materiałów,
ułatwia transport



CENA I INFO

www.strima.com/i4Lb4



TEXI 5003

Stopka z liniałami prawym
i lewym do równego stebno-
wania w zakresie 5 - 55 mm



CENA I INFO

www.strima.com/i4Lb6



TEXI 5004

Stopka PTFE z pierścieniami
do szycia wielowarstwowych
projektów



CENA I INFO

www.strima.com/i4Lb7

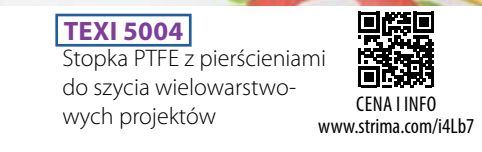

TEXI 5006

Stopka podwójnie
zwijająca 1/8" (3,2 mm)



CENA I INFO

www.strima.com/i4Lb9

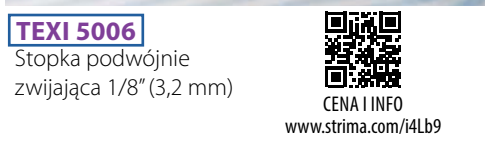



TEXI 5007

Stopka zwijająca 1/8"
(3.2 mm)



CENA I INFO

www.strima.com/i4LbB



TEXI 5010

Stopka do marszczenia
regulowana



CENA I INFO

www.strima.com/i4LbE

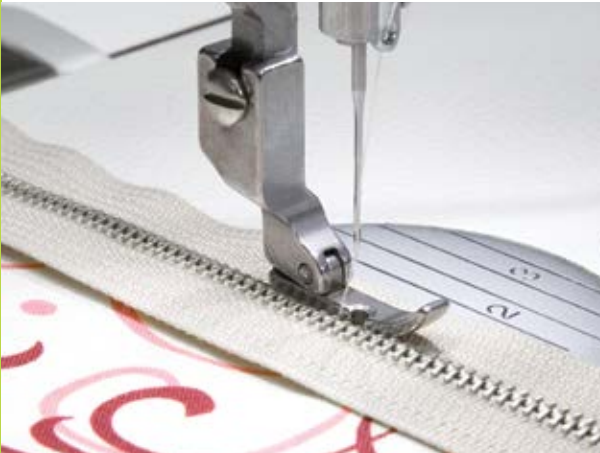

Stopka krawędziowa wąska
do wszywania zamków i szycia
blisko krawędzi

TEXI 5008

Lewa



CENA I INFO

www.strima.com/i4LbC

TEXI 5009

Prawa



CENA I INFO

www.strima.com/i4LbD



TEXI 5011

Stopka do
wszywania zamków
z wąskimi płozami



CENA I INFO

www.strima.com/i4LbF

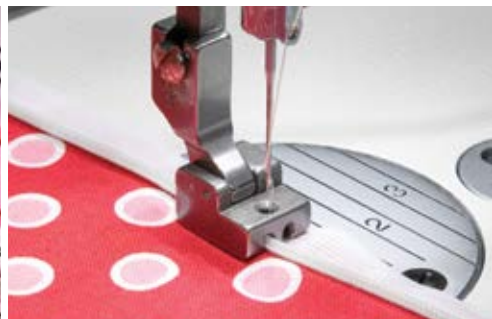

TEXI 5012

Stopka do wszywania
zamków krytych



CENA I INFO

www.strima.com/i4LbG

**TEXI 5013**

Stopka uniwersalna



CENA I INFO

www.strima.com/i4LbH

**TEXI 5014**

Stopka rolkowa do trudnych materiałów, skaju i skór



CENA I INFO

www.strima.com/i4LbI

**TEXI 5015**

Stopka z prowadnikiem do naszywania taśmy o szer. do 4.8 mm



CENA I INFO

www.strima.com/i4LbJ

**TEXI 5020**

Stopka do wszywania kedry 3,2 mm lewa



CENA I INFO

www.strima.com/i4LbO



Stopka kompensacyjna do równego stebnowania, 1,0 mm

TEXI 5016

Prawa



CENA I INFO

www.strima.com/i4LbK

TEXI 5017

Lewa



CENA I INFO

www.strima.com/i4LbL

Stopka pokryta PTFE
kompensacyjna do równego
stebnowania, 1,0 mm

TEXI 5018

Prawa



CENA I INFO

www.strima.com/i4LbM

TEXI 5019

Lewa



CENA I INFO

www.strima.com/i4LbN



TEXI 5021

Stopka do zwijacza



CENA I INFO

www.strima.com/i4LbP



TEXI 5022

Stopka do delikatnych
materiałów



CENA I INFO

www.strima.com/i4LdR

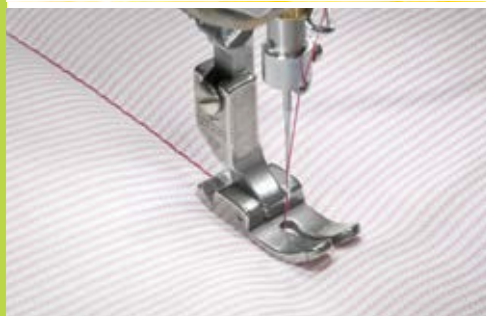

TEXI 5023

Stopka do grubych
materiałów



CENA I INFO

www.strima.com/i4LdS



TEXI 6001

Łamownik podwójnie
zawijający 30/8 mm



CENA I INFO

www.strima.com/i4LbQ



8 mm



TEXI 6002

Lamownik składający na pół 5/8" (16/8 mm)



CENA I INFO

www.strima.com/i4LBR

7,95 mm



TEXI 6003

Zwijacz podwójnie podwijający 3/8" (9,53 mm)



CENA I INFO

www.strima.com/i4LBS

9,53 mm



TEXI 4004

Wkręt uniwersalny do mocowania lamowników, zwijaczy i linałów (2 szt.)



CENA I INFO

www.strima.com/i4LaZ



TEXI 4009

Liniał magnetyczny



CENA I INFO

www.strima.com/i4Laf



TEXI 4010

Liniał magnetyczny - długi (50 mm) i bardzo mocny



CENA I INFO

www.strima.com/i4Lag



TEXI 4021

Liniał uchylny



CENA I INFO

www.strima.com/i4Lar

Igły *texi* do maszyn przemysłowych



CENA I INFO

www.strima.com/s1015

Czubki igieł do tkanin i dzianin

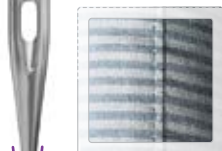
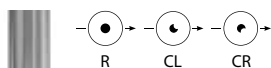

Okrągły standardowy czubek do tkanin, ale także do dzianin i skóry w zależności od grubości igły i technologii szycia

CL i CR - z rowkiem wyprowadzającym nitkę z oczka, do twardych materiałów

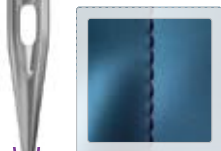

Okrągły bardzo ostry czubek do tkanin o gęstym splocie, np. mikrofaza, jedwab, a także do stebnowania widocznych elementów



Okrągły czubek z małą kulką do delikatnych dzianin z cienkiej przędzy o dużej gęstości oczek oraz do denimu



Okrągły czubek ze średnią kulką do grubszych dzianin i materiałów elastycznych



Okrągły czubek z dużą kulką do grubych dzianin, a także cienkiej lycry w kombinacji z małą średnicą igły (65-70)



Okrągły czubek ze specjalną kulką do dzianin z gumką, dzianin o zróżnicowanym splocie, a także grubej lycry



Specjalny okrągły czubek do przyszywania guzików

Ostrza igieł do skór, materiałów powlekanych, wymagających nacięcia podczas szycia



Do wszystkich rodzajów skóry, tnie poprzecznie do kierunku ściegu, dając krótki, mocny ścieg

PCL i PCR - z rowkiem wyprowadzającym nitkę z oczka

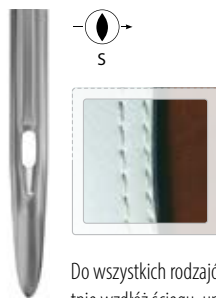

Do wszystkich rodzajów skóry, tnie wzdłuż ściegu, umożliwiając prosty długi ścieg

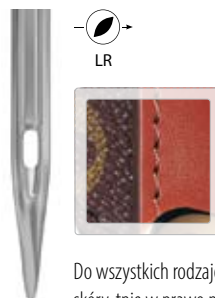

Do wszystkich rodzajów skóry, tnie w prawo po skosie, dając dekoracyjny ścieg z lekkim skrętem w lewo

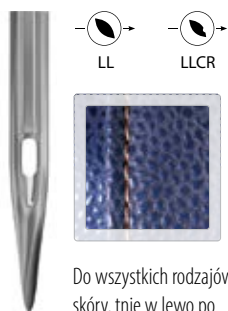

Do wszystkich rodzajów skóry, tnie w lewo po skosie, dając prosty, lekko zagłębiony ścieg



Do grubej, suchej, twardej skóry, tnie wzdłuż ściegu, dając prosty, zagłębiony ścieg

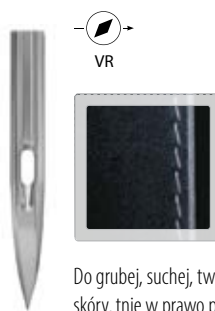

Do grubej, suchej, twardej skóry, tnie w prawo po skosie, dając dekoracyjny ścieg z lekkim skrętem w lewo

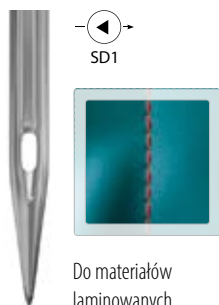

Do materiałów laminowanych

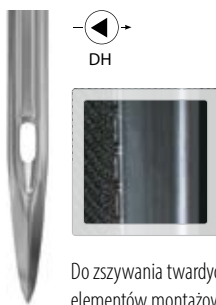

Do zszywania twardych elementów montażowych tapicerki z tkaniną lub skórą

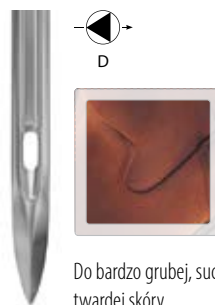

Do bardzo grubej, suchej, twardej skóry, umożliwia prosty ścieg



Igły *texi* do maszyn domowych

Z kolorami łatwiej wybierzesz!

Zastosowanie

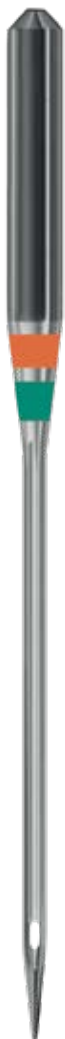
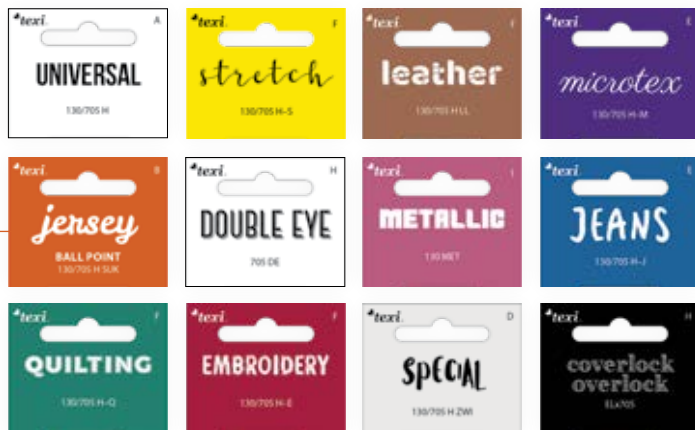

60 65 70 75 80 90 100 110 120 125 130

Grubość igły (w nm)

TEXI UNIVERSAL

Igły uniwersalne przeznaczone do większości tkanin, także do dzianin, tkanin syntetycznych itp.



CENA I INFO

www.strima.com/s1001

	UNIVERSAL 130/705 H 5x60
	UNIVERSAL 130/705 H 5x70
	UNIVERSAL 130/705 H 5x80
	UNIVERSAL 130/705 H 5x90
	UNIVERSAL 130/705 H 5x100
	UNIVERSAL 130/705 H 5x110
	UNIVERSAL 130/705 H 5x120
	UNIVERSAL 130/705 H 2x70, 2x80, 1x90
	UNIVERSAL 130/705 H 1x70, 2x80, 1x90, 1x100
	UNIVERSAL 130/705 H 10x70
	UNIVERSAL 130/705 H 10x80
	UNIVERSAL 130/705 H 10x90
	UNIVERSAL 130/705 H 10x100
	UNIVERSAL 130/705 H 2x70, 3x80, 3x90, 2x100
	UNIVERSAL 130/705 H 10x60-110



TEXI STRETCH

Igły do stretchu i dzianin



CENA I INFO

www.strima.com/s1002

	STRETCH 130/705 H-S 5x65
	STRETCH 130/705 H-S 5x75
	STRETCH 130/705 H-S 5x90
	STRETCH 130/705 H-S 3x75, 2x90



TEXI JERSEY

Igły kulkowe (średnia kulka) do szycia materiałów elastycznych



CENA I INFO

www.strima.com/s1003

	JERSEY 130/705 H SUK 5x70
	JERSEY 130/705 H SUK 5x80
	JERSEY 130/705 H SUK 5x90
	JERSEY 130/705 H SUK 5x100
	JERSEY 130/705 H SUK 2x70, 2x80, 1x90



TEXI JEANS

Igły do denimu (jeansu)



CENA I INFO

www.strima.com/s1004

	JEANS 130/705 H-J 5x70
	JEANS 130/705 H-J 5x80
	JEANS 130/705 H-J 5x90
	JEANS 130/705 H-J 5x100
	JEANS 130/705 H-J 5x110
	JEANS 130/705 H-J 2x90, 2x100, 1x110

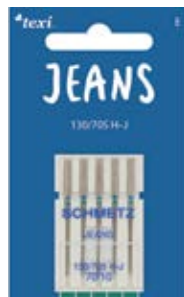

TEXI LEATHER

Igły do szycia skóry, sztucznej skóry oraz podobnych materiałów.



CENA I INFO

www.strima.com/s1005

	LEATHER 130/705 H LL 5x70
	LEATHER 130/705 H LL 5x80
	LEATHER 130/705 H LL 5x90
	LEATHER 130/705 H LL 5x100
	LEATHER 130/705 H LL 5x110
	LEATHER 130/705 H LL 5x120
	LEATHER 130/705 H LL 2x80, 2x90, 1x100



TEXI MICROTEx

Igły do jedwabiu i mikrofazy



CENA I INFO

www.strima.com/s1006

	MICROTEx 130/705 H-M 5x60
	MICROTEx 130/705 H-M 5x70
	MICROTEx 130/705 H-M 5x80
	MICROTEx 130/705 H-M 5x90
	MICROTEx 130/705 H-M 2x60, 2x70, 1x80



TEXI QUILTING

Igły do quiltingu oraz patchworku



CENA I INFO

www.strima.com/s1007

	QUILTING 130/705 H-Q 5x75
	QUILTING 130/705 H-Q 5x90
	QUILTING 130/705 H-Q 3x75, 2x90



TEXI EMBROIDERY

Igły do haftu, z większym oczkiem do grubszych nici



CENA I INFO

www.strima.com/s1008

- EMBROIDERY 130/705 H-E 5x75
- EMBROIDERY 130/705 H-E 5x90
- EMBROIDERY 130/705 H-E 3x75, 2x90

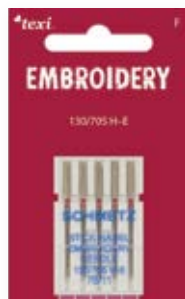

TEXI METALLIC

Igły do haftu niciami metalicznymi z bardzo długim oczkiem (2 mm)



CENA I INFO

www.strima.com/s1009

- METALLIC 130 MET 5x80
- METALLIC 130 MET 5x90



TEXI DOUBLE EYE

Igły z podwójnym oczkiem przeznaczone do jednoczesnego szycia dwoma nitkami



CENA I INFO

www.strima.com/s1010

- DOUBLE EYE 705 DE 5x80



TEXI UNIVERSAL TWIN

Igła podwójna do ściegu ozdobnego, aplikacji i ściegu zygzakowego



CENA I INFO

www.strima.com/s1011

- UNIVERSAL TWIN 130/705 H ZWI NE 2,0-80
- UNIVERSAL TWIN 130/705 H ZWI NE 2,5-80
- UNIVERSAL TWIN 130/705 H ZWI NE 3,0-90
- UNIVERSAL TWIN 130/705 H ZWI NE 4,0-80
- UNIVERSAL TWIN 130/705 H ZWI NE 4,0-90
- UNIVERSAL TWIN 130/705 H ZWI BR NE 6-100
- UNIVERSAL TWIN 130/705 H ZWI BR NE 8-100



TEXI COVERLOCK OVERLOCK

Igły do overloków i cowerloków



CENA I INFO

www.strima.com/s1012



OVERLOCK/COVERLOCK ELX705 5x80
OVERLOCK/COVERLOCK ELX705 5x90
OVERLOCK/COVERLOCK ELX705 CF 5x65
OVERLOCK/COVERLOCK ELX705 CF 5x80
OVERLOCK/COVERLOCK ELX705 CF 5x90
OVERLOCK/COVERLOCK ELX705 SUK CF 5x65
OVERLOCK/COVERLOCK ELX705 SUK CF 5x80
OVERLOCK/COVERLOCK ELX705 SUK CF 5x90

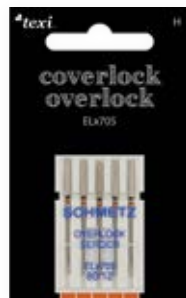

TEXI CREATIVE 5

Igły do maszyn domowych MIX,
5 sztuk



CENA I INFO

www.strima.com/i4RAK

TEXI CREATIVE 9+

Igły do maszyn domowych MIX,
9 sztuk



CENA I INFO

www.strima.com/i4RAI

TEXI CREATIVE 10

Igły do maszyn domowych MIX,
10 sztuk



CENA I INFO

www.strima.com/i4Tiw

texi®. Domowe maszyny do szycia

TEXI JOY 13

Automatyczna, wieloczynnościowa maszyna do szycia,
13 programów szycia



CENA I INFO
www.strima.com/s1013



3 lata gwarancji

bezpieczna dla dziecka

najlepsza na start

Główne funkcje

- 13 wzorów ściegów (m.in. ściegi proste, zygzaki i ozdobne)
- 4 stopniowa dziurka
- Regulacja długości (do 3,6 mm) i szerokości (do 4 mm) ściegu
- Szycie wstecz
- Maksymalna prędkość szycia 650 ściegów/minutę
- Zatrzaskowe mocowanie stopki – SYSTEM MATIC
- Łatwy system nawlekania
- Wolne ramię – łatwe szycie na okrągło
- Lampka LED
- Obcinacz nitki
- Chwytnacz wahadłowy

Wyposażenie

stopka uniwersalna, stopka do obszywania dziurek, 2 szpulki, zestaw igieł, rozcinacz dziurek, uchwyt zabezpieczający szpulkę, rozrusznik nożny (pedał), oliwiarka, miękki pokrowiec



Wolne ramię do szycia na okrągło

enjoy
YOUR COLOR!



PAMIĘTAJ O:

TEXI JOY 13 EXTENSION TABLE

Stół powiększający pole pracy o wymiarach: 22,5 cm x 32 cm



CENA I INFO
www.strima.com/i40QT



www.strima.com

TEXI FOX 25

Automatyczna, wieloczynnościowa maszyna do szycia,
25 programów szycia

3 lata
gwarancji



CENA I INFO

www.strima.com/i4SZU



Wyposażenie

stopka uniwersalna, stopka do wszywania zamków, stopka do obszywania dziurek, prowadnik, 3 szpulki, zestaw igieł, rozcinacz dziurek, pędzelek, śrubokręt, śrubokręt do płytki ścięgowej, rozrusznik nożny (pedał), oliwiarka, miękki pokrowiec

WYPOSAŻENIE
MASZYNY



Główne funkcje

- 25 różnych rodzajów ściegów (w tym proste, zygzak i dekoracyjne)
- 4-stopniowa dziurka
- Regulacja długości (do 4 mm) i szerokości (do 4 mm) ściegu
- Podnoszenie stopki 5,5 mm
- Szycie wstecz
- Maksymalna prędkość szycia 700 ściegów/minutę
- Zatrzaśkowe mocowanie stopki – SYSTEM MATIC
- Wolne ramię – łatwe szycie na okrągło
- Lampka (LED)
- Obcinacz nitki
- Chwytnacz wahadłowy
- Nawlekacz igły

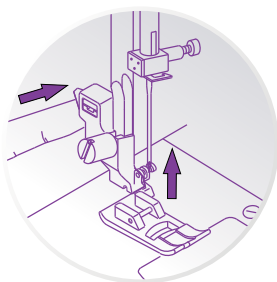
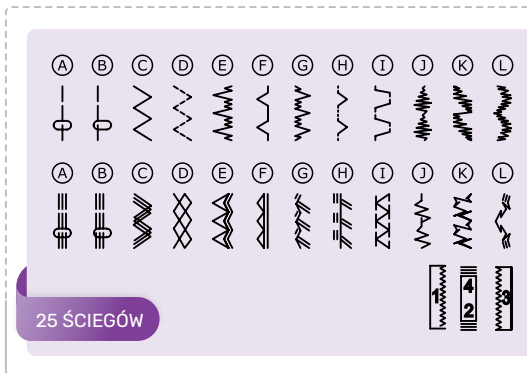

SYSTEM MATIC
szybka wymiana stopki

PAMIĘTAJ O:

TEXI FOX 25 EXTENSION TABLE

Stolik powiększający pole pracy
o wymiarach: 36 cm x 26 cm



CENA I INFO

www.strima.com/i45fs

www.strima.com



TEXI JOY 48

Automatyczna, wieloczynnościowa maszyna do szycia,
48 programów szycia

3 lata
gwarancji



CENA I INFO
www.strima.com/i40W6



Wyposażenie

stopka uniwersalna, stopka do wszywania zamków, stopka do obszywania dziurek, prowadnik, 3 szpulki, zestaw igieł, rozcinacz dziurek, pędzelek, śrubokręt, rozrusznik nożny (pedał), oliwiarka, miękki pokrowiec

WYPOSAŻENIE
MASZYNY



Główne funkcje

- 48 wzorów ściegów (m.in. ściegi proste, zygzaki i ozdobne)
- 4-stopniowa dziurka
- Regulacja długości (do 5 mm) i szerokości (do 5 mm) ściegu
- Elektroniczny wybór i regulacja szerokości ściegów
- Pozycjonowanie igły
- Podnoszenie stopki 5,5 mm
- Szycie wstecz
- Maksymalna prędkość szycia 700 ściegów/minutę
- Zatraskowe mocowanie stopki –SYSTEM MATIC
- Wolne ramię – łatwe szycie na okrągło
- Lampka (LED)
- Obcinacz nitki
- Chwytnicz wahadłowy



Wolne ramię do szycia na okrągło

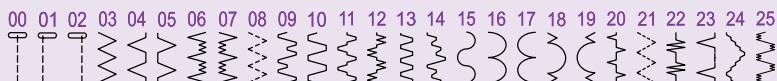
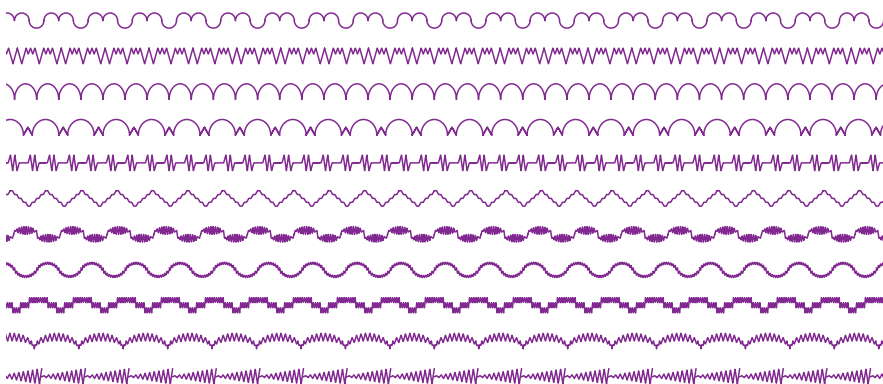

4-STOPNIOWA
DZIURKA

48 ŚCIEGÓW

TEXI BLACK&WHITE

Automatyczna, wieloczynnościowa maszyna do szycia sterowana komputerowo, 200 programów szycia



CENA I INFO

www.strima.com/i4Rfl

3 lata
gwarancji

najbogatsze
wyposażenie
w standardzie

200
programów



Wyposażenie:

zestaw igieł, igła podwójna, 4 szpulki, rozcinacz dziurek ze szczotką, śrubokręt do płytki ścięgowej, nasadka szpulki, śrubokręt, pomocniczy trzpień szpulki, stopka do ściegu satynowego, stopka do wszywania zamków, stopka do ściegu krytego, stopka do guzików, stopka do obszywania dziurek, rozrusznik nożny (pedał).

WYPOSAŻENIE
MASZYNY

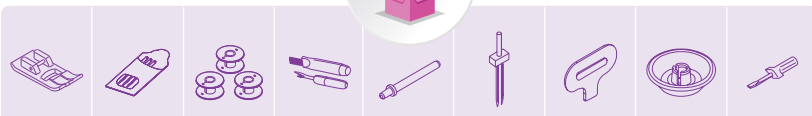

Główne funkcje

- 200 programów szycia (m.in. 9 rodzajów automatycznego obszywania dziurki, ściegi proste, zygzaki, owerlokowe i ozdobne)
- Alfabet
- Płynna regulacja długości (do 4,5 mm) i szerokości ściegu (do 7 mm)
- Szycie wstecz
- Szycie podwójną igłą
- Maksymalna prędkość szycia 750 ściegów/minutę
- Elektroniczna regulacja prędkości szycia
- Wyświetlacz LCD
- Funkcja Start/Stop
- Pozycjonowanie igły (góra/dół)
- Automatyczny nawlekacz igły
- Zatraskowe mocowanie stopki - SYSTEM MATIC



- Wolne ramię - łatwe szycie na okrągło
- Lampka LED
- Chwytnacz rotacyjny
- Metalowe podzespoły
- Dźwignia wyłączenia transportera

PAMIĘTAJ O:

TEXI BLACK&WHITE EXTENSION TABLE

Stolik powiększający pole pracy 42 cm x 29 cm



CENA I INFO

www.strima.com/i4Rt0



DOMOWE MASZYNY DO SZYCIA

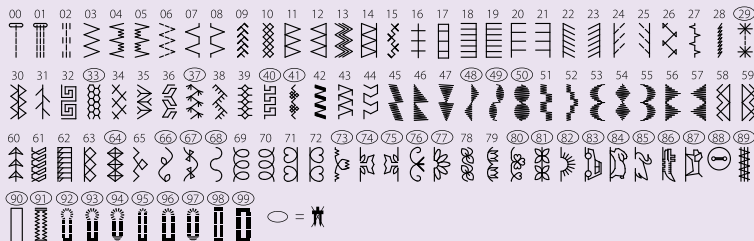

00 01 02 03 04 05 06 07 08 09 10 11 12 13 14 15 16 17 18 19 20 21 22 23 24 25 26 27 28 29 30 31 32 33 34 35 36 37 38 39 40 41 42 43 44 45 46 47 48 49 50 51 52 53 54 55 56 57 58 59 60 61 62 63 64 65 66 67 68 69 70 71 72 73 74 75 76 77 78 79 80 81 82 83 84 85 86 87 88 89 90 91 92 93 94 95 96 97 98 99

0 1 2 3 4 5 6 7 8 9 A B C D E F G H I J K L M N O P Q R S T U V W X Y Z a b c d e f g h i j k l m n o p q r s t u v w x y z @ ! ? & □ ' " , . - / : ; A A E a a a e e

è é ç œ ÷ | ñ ñ ò ò ò ò ù ù ù

200 STITCHES

TEXI BALLERINA

Automatyczna, wieloczynnościowa maszyna sterowana komputerowo, 200 programów szycia



CENA I INFO
www.strima.com/i4MDV

Główne funkcje

- 200 programów szycia
- Alfabet
- Płynna regulacja dł. (do 5 mm) i szer. ściegu (do 7 mm)
- Szycie wstecz
- Elektroniczna regulacja prędkości szycia (maks. 750 ściegów/min)
- Przyciski:

usuwanie wzorów (CL), programowanie wzorów (ME), lustrzane odbicie (MI), powtarzanie wzorów (RE), start/stop, wolne szycie

- Pozycjonowanie igły (góra/dół)
- Szycie "ścieg po ściegu"
- Regulacja docisku stopki
- Dźwignia opuszczania transportera
- Zatrzaskowe mocowanie stopki – SYSTEM MATIC
- Wolne ramię – łatwe szycie na okrągło

Wyposażenie

stół powiększający pole pracy 50 x 38 cm, lampka LED, obcinacz nitki, nawlekacz igły, rozpruwacz z pędzelkiem, 4 szpulki, uchwyty szpulki (mały i duży), zestaw śrubokrętów, zestaw stopek, sztywne ochraniacz

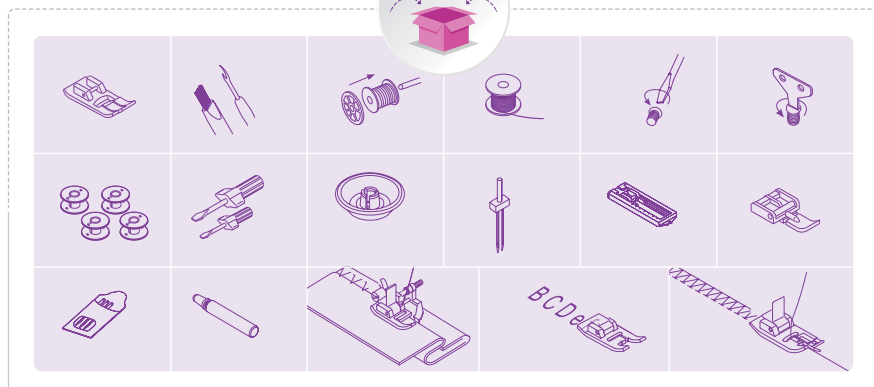



3 lata
gwarancji

najbogatsze
wyposażenie
w standardzie

200
programów

001	002	003	004	005	006	007	008	009	010	011	012	013	014	015	016	017	018	019	020	021	022	023	024	025
026	027	028	029	030	031	032	033	034	035	036	037	038	039	040	041	042	043	044	045	046	047	048	049	050
051	052	053	054	055	056	057	058	059	060	061	062	063	064	065	066	067	068	069	070	071	072	073	074	075
076	077	078	079	080	081	082	083	084	085	086	087	088	089	090	091	092	093	094	095	096	097	098	099	100
101	102	103	104	105	106	107	108	109	110	111	112	113	114	115	116	117	118	119	120	121	122	123	124	125
126	127	128	129	130	131	132	133	134	135	136	137	138	139	140	141	142	143	144	145	146	147	148	149	150
151	152	153	154	155	156	157	158	159	160	161	162	163	164	165	166	167	168	169	170	171	172	173	174	175
176	177	178	179	180	181	182	183	184	185	186	187	188	189	190	191	192	193	194	195	196	197	198	199	200
p	q	r	s	t	u	v	w	x	y	z	[]	/	.	-	0	1	2	3	4	5	6	7	8	9

200 ŚCIEGÓW

Pobierz tutorial



Uszyj spódniczkę Pettitskirt



pl.strima.com/tutorial-petitskirt



TEXI BALLERINA



PAMIĘTAJ O:

TEXI ENJOY SEWING MACHINE BAG

Torba do domowych maszyn do szycia



CENA I INFO
www.strima.com/i4NzY



TEXI ENJOY MAXI SEWING MACHINE BAG

Torba do domowych maszyn do szycia, duża



CENA I INFO
www.strima.com/i4UBH



TEXI ENJOY OVERLOCK BAG

Torba do domowego overloka



CENA I INFO
www.strima.com/i4NzZ



TEXI ENJOY MAXI OVERLOCK BAG

Torba do domowego overloka, duża



CENA I INFO
www.strima.com/i4Ti5



TEXI JOYLOCK

2, 3, 4-nitkowy overlok do wszystkich rodzajów materiałów

3 lata gwarancji

idealny do dzianin



CENA I INFO
www.strima.com/i4NxQ

WYPOSAŻENIE
MASZYNY

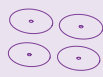

Główne funkcje

- 7 rodzajów ściegów overlokowych, m.in. ścieg rolujący (merezka)
- Transport różnicowy, regulowany w zakresie 0.7 – 2.0 mm
- Maksymalna prędkość szycia 1200 ściegów/minutę
- Długość ściegu 1 – 5 mm
- Szerokość ściegu do 6 mm
- Podnoszenie stopki do 6 mm
- Regulacja docisku stopki
- Zintegrowany mechaniczny obcinacz nitki ①
- Pojemnik na ścinki ②

- Zabezpieczenie przed uruchomieniem maszyny podczas nawlekania nici na chwytacze
- Regulacja szerokości obcinania materiału
- Wylączony nóż górny
- Kolorowy system nawlekania nici

Wyposażenie

lampka, 4 x podkładka pod szpulkę, 4 x osłona szpulki, 4 x uchwyt szpulki, pinceta, wkrętak x 2, klucz, pędzelek czyszczący, olej do maszyny, zestaw igieł, prowadnik nici, ślepy chwytacz, nóż ruchomy, rozrusznik nożny (pedał), miękki pokrowiec, torba na akcesoria



PAMIĘTAJ O:

TEXI 4079

Niezbędny zestaw do czyszczenia do maszyny do szycia



CENA I INFO
www.strima.com/i45E3

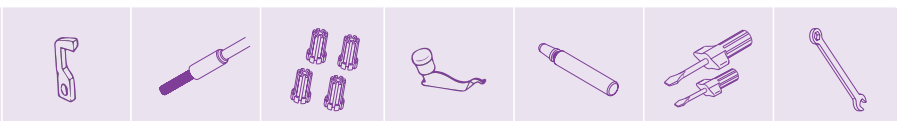

RODZAJE ŚCIEGÓW

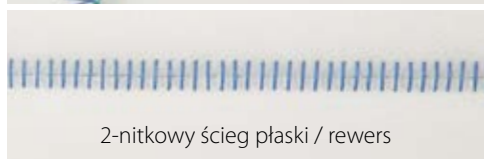
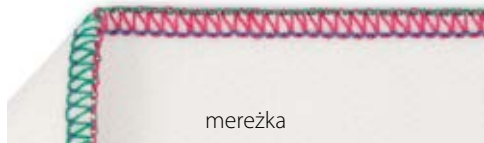
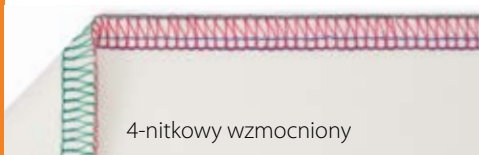

Pomyśl o zestawie stopek,
które mogą Ci się przydać

TEXI 1050



www.strima.com/i4MIQ



ŁATWE NAWLEKANIE

- chwytnicz dolny
- chwytnicz górny
- igła prawa
- igła lewa

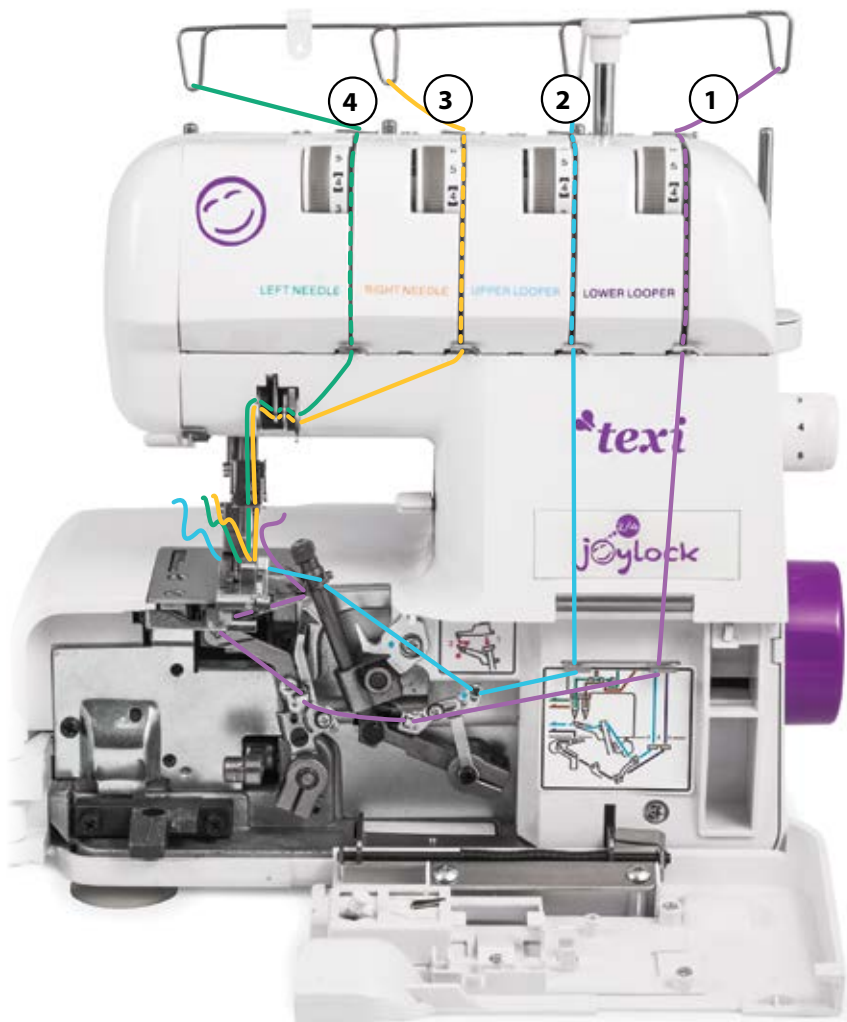
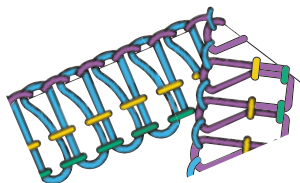

TEXI TEGRA

2, 3, 4-nitkowy
owerlok do wszystkich
rodzajów materiałów



CENA I INFO
www.strima.com/i45ZV

3 lata
gwarancji



Wolne ramię do szycia na okrągło

Wyposażenie

Igły - 3 sztuki, tarcza szpulki,
dolny nóż, prowadnik,
pędzelek czyszczący,
pinceta, 3 śrubokręty S, M, L,
uchwyt na 2 igły, rozrusznik
nożny (pedał), miękki
pokrowiec

DODATKOWO
W ZESTAWIE

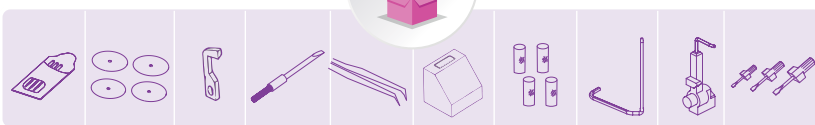

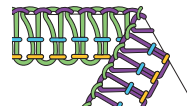

3-nitkowy overlokowy szeroki

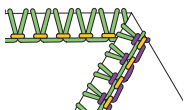

3-nitkowy overlokowy wąski

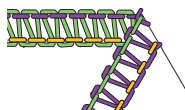

overlokowy, obrzucający 3-nitkowy szeroki

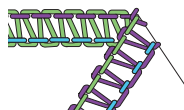

overlokowy, obrzucający 3-nitkowy wąski

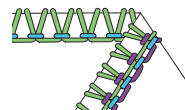

3-nitkowy dekoracyjny



3-nitkowy marszczony

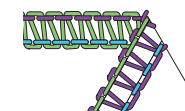

3-nitkowy marszczony, overlokowy

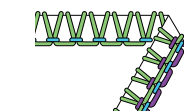

2-nitkowy overlokowy, szeroki



2-nitkowy overlokowy, wąski

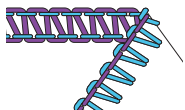

overlokowy 2-nitkowy szeroki

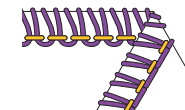

overlokowy 2-nitkowy, wąski, mierzka

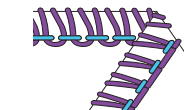

2-nitkowy marszczony, mierzka

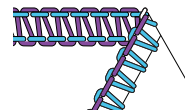

Główne funkcje

- Liczba nici overloka: 2, 3 lub 4
- Szerokość ściegu: do 6,7 mm
- System igieł: 130/705H (HA1x 1)
- Długość ściegu: 1 - 4 mm
- Maksymalna prędkość szycia - do 1200 ściegów/minutę
- Podnoszenie stopki do 4 mm
- Regulacja transportu różnicowego w zakresie od 0,7 do 2,0 mm
- Regulacja docisku stopki
- Manualny obcinacz nitki
- Pojemnik na ścinki materiału
- Ślepy chwytacz
- Regulacja szerokości cięcia
- Możliwość wyłączenia górnego noża
- Łatwy i czytelny (kolorowy) system nawlekania
- Lampka (LED)
- Mechanizm zwalniający naprężenie nici
- Wolne ramię do szycia na okrągło

Rozkładana szafka na dwie maszyny



TEXI SESAME DUO

Pracownia krawiecka w jednej szafce?
Kredki, nożyczki, miarka, rozcinacz do dziurek, szpilki, igły, nici, pinceta, szpulki, stopki, prowadniki i inne akcesoria krawieckie w jednym miejscu. No i najważniejsze - maszyna i overlok także. Robisz klik i maszyna do szycia jak za dotknięciem czarodziejskiej różdżki wyłania się spod blatu, a półkę z overlokiem wysuwasz jednym ruchem ręki. Jak skończysz, robisz klap, klap, klap i... masz wszystko uporządkowane w zamkniętej szafce.





Zobacz szafkę w akcji



Wybierz swój kolor



CENA I INFO
strima.com/s1032

texi. Akcesoria do maszyn domowych

TEXI 0008

Stopka do wszywania
zamków krytych, wysokie
mocowanie



CENA I INFO

www.strima.com/i4LZI



TEXI 0009

Stopka do haftowania,
cerowania i pikowania



CENA I INFO

www.strima.com/i4LZI



TEXI 0010

Stopka do zszywania
i marszczenia



CENA I INFO

www.strima.com/i4LZI

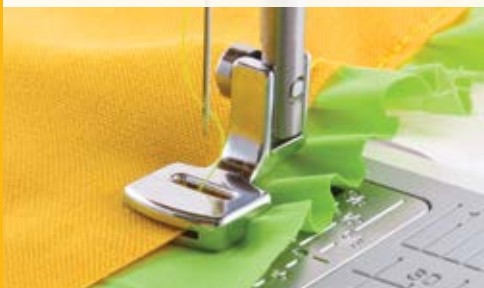

TEXI 0011

Stopka do marszczenia



CENA I INFO

www.strima.com/i4LZK



TEXI 0012

Stopka do naszywania
aplikacji



CENA I INFO

www.strima.com/i4LZL



TEXI 0013

Stopka z rolkami do
trudnych materiałów



CENA I INFO

www.strima.com/i4LZM



TEXI 0014

Stopka do krawędziowego
łączenia dwóch tkanin



CENA I INFO
www.strima.com/i4LZN

**TEXI 0019**

Stopka dwustronna, szeroka
do wszywania zamków
i szycia krawędziowego



CENA I INFO
www.strima.com/i4LZS



Stopka dwustronna, wąska do wszywania
zamków

TEXI 0017

Niski typ mocowania



CENA I INFO
www.strima.com/i4LZQ

**TEXI 0018**

Wysoki typ mocowania

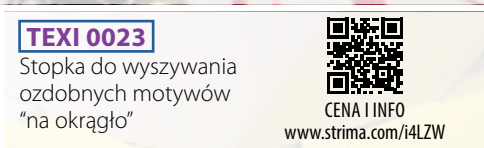

CENA I INFO
www.strima.com/i4LZR

**TEXI 0022**

Stopka do zakładki
i marszczenia



CENA I INFO
www.strima.com/i4LZV

**TEXI 0023**

Stopka do wyszywania
ozdobnych motywów
"na okrągło"



CENA I INFO
www.strima.com/i4LZW



TEXI 0024

Stopka z górnym transportem ułatwiająca szycie wielu warstw materiału



CENA I INFO
www.strima.com/i4LZX



TEXI 0025

Stopka owerlokowa do jednoczesnego obrzucania i obcinania materiału



CENA I INFO
www.strima.com/i4LZY



TEXI 0026

Stopka do naszywania ozdobnych sznurków



CENA I INFO
www.strima.com/i4LZt



System MATIC

Zmieniaj stopki w 5 sekund!

Zmierz wysokość od dołu stopki do śruby mocującej uchwyt igły.

Jeśli odległość wynosi około **1,5 cm** – oznacza to, że mamy niski typ mocowania stopki. Dotyczy większości maszyn.

Jeżeli odległość wynosi około **2,5 cm** – jest to wysoki typ mocowania stopki.



STOPKI MATIC

TEXI 1001

Niskie mocowanie
wysokość (1,5 cm)



Niskie

TEXI 1002

Wysokie mocowanie
wysokość (2,5 cm)



Wysokie



TEXI 1003

Stopka uniwersalna
do ściegu prostego
i zygzakowego



CENA I INFO
www.strima.com/i4LZy



TEXI 1004

Stopka wzmacniona
plastikowa do ściegu
prostego i zygzakowego



CENA I INFO
www.strima.com/i4La0

TEXI 1005

Stopka do
4-stopniowego
obszywania
dziurek



CENA I INFO

www.strima.com/i4La1

TEXI 1006

Stopka do
naszywania aplikacji,
szycia ściągim
satynowym



CENA I INFO

www.strima.com/i4La2

TEXI 1008

Stopka do
przyszywania
guzików



CENA I INFO

www.strima.com/i4La4

TEXI 1009

Stopka
dwustronna
do wszywania
zmków



CENA I INFO
www.strima.com/i4La5

TEXI 1010

Stopka podwójnie
zwijająca 1/16"
(1,6 mm)



CENA I INFO
www.strima.com/i4La6

TEXI 1011

Stopka
z regulowanym
prowadnikiem



CENA I INFO
www.strima.com/i4La7

TEXI 1012

Stopka do naszywania ozdobnych sznurków i gumek



CENA I INFO

www.strima.com/i4La8



TEXI 1013

Stopka do ścięgu overlokowego



CENA I INFO

www.strima.com/i4La9



TEXI 1014

Prowadnik krawędziowy idealny do pikowania



CENA I INFO

www.strima.com/i4LaA



TEXI 1015

Stopka do wszywania zamków krytych



CENA I INFO

www.strima.com/i4LaB



TEXI 1016

Stopka z rolkami do trudnych „klejących się” materiałów



CENA I INFO

www.strima.com/i4LaC



TEXI 1017

Stopka do wszywania zaprasowanej lamówki, regulowana 5 -20 mm



CENA I INFO

www.strima.com/i4LZZ





TEXI 2001

Uchwyt mocujący
lamowniki i zwiżacze



CENA I INFO
www.strima.com/i4LaD



LAMOWANIE

LAMOWNIK



ZWIJANIE

ZWIJACZ

TEXI 2002

A = 7/32" (5,5 mm)

TEXI 2003

A = 1/10" (2,5 mm)

TEXI 2004

A = 1/4" (6,4 mm)

TEXI 2005

A = 3/8" (9,5 mm)

TEXI 2006

A = 5/8" (16 mm)

TEXI 2007

A = 7/8" (22 mm)

texi. Uniwersalne akcesoria



TEXI 3003 SET 3

Zestaw 3 szpulek metalowych, płaskich



CENA I INFO
www.strima.com/i4La0



TEXI 3004 SET 3

Zestaw 3 szpulek plastikowych, płaskich



CENA I INFO
www.strima.com/i4LaP



TEXI 3010 SET 3

Zestaw 3 szpulek plastikowych, soczewkowych



CENA I INFO
www.strima.com/i4LaV



TEXI 4005

Pinceta



CENA I INFO
www.strima.com/i4Laa



TEXI 4033

Pudełko do przechowywania 25 szpulek



CENA I INFO
www.strima.com/i4Lb3



TEXI 4079

Zestaw do czyszczenia maszyny do szycia



CENA I INFO
www.strima.com/i4SE3

TEXI 4047

Przyrząd do wywracania pasków i szlufek oraz przeciągania sznurka



CENA I INFO
www.strima.com/i4NfZ

TEXI 4083

Rozcinacz dziurek, rozpruwacz



CENA I INFO
www.strima.com/i4Tu2

TEXI 4049

Igła do przeciągania nitki



CENA I INFO
www.strima.com/i4Nfb

TEXI 4048

Przyrząd do ręcznego wygładzania szwów



CENA I INFO
www.strima.com/i4Nfa



TEXI 4013

Kredka do tkanin:
biała i kolor



CENA I INFO
www.strima.com/i4Laj



TEXI 4014

Pisak znikający
fioletowo-różowy



CENA I INFO
www.strima.com/i4Laj



TEXI 4015

Pisak znikający:
fioletowy lub różowy



CENA I INFO
www.strima.com/s1016



TEXI 4016

Korektor pisaków
znikających



CENA I INFO
www.strima.com/i4Laj



TEXI 4040

Kredka krawiecka w aplikatorze



CENA I INFO
www.strima.com/s1017



TEXI 4041

Kredka krawiecka -
wkład do aplikatora



CENA I INFO
www.strima.com/s1018



główki
w kształcie
kwiatków

TEXI 4075

Szpilki stalowe niklowane,
główki w kształcie
kwiatków 48 x 0,6 mm
opakowanie 80 szt.



CENA I INFO
www.strima.com/i4Nfr



szklane
główki

TEXI 4076

Szpilki stalowe
niklowane ze szklanymi
główkami 48 x 0,6 mm
opakowanie 75 szt.



CENA I INFO
www.strima.com/i4Nfs



TEXI 4046

Narzędzie do wykonywania
otworów na nity, zatrzaski,
oczka itp.



CENA I INFO
www.strima.com/i4Nfy



TEXI 4034

Nawleczak nitki



CENA I INFO
www.strima.com/i4LaR



TEXI 4029

Magnetyczna poduszka
do igieł i szpilek



CENA I INFO
www.strima.com/s1019

TEXI 4082

Rozcinacz ściegu, 2 szt.



CENA I INFO
www.strima.com/i4Tu1





TEXI 4080

Zestaw sprytnych akcesoriów dla każdej krawcowej



CENA I INFO
www.strima.com/i45E4

TEXI 4011

Szczotka do podnoszenia włosów



CENA I INFO
www.strima.com/i4Lah

TEXI BOX 15

Pudełko z motylami zawiera: 15 szpułek nici w różnych kolorach, 5 igieł i przewodnik po igłach Texi



CENA I INFO
www.strima.com/i4Rwi

TEXI 4006

Rolka czyszcząca z uchwytem (1 rolka = 10 m)



CENA I INFO
www.strima.com/s1020

TEXI 4006R

Rolka wymienna



TEXI 4035

Zestaw 3 zwijaczy
do zaprasowywania
łamówki



CENA I INFO
www.strima.com/i4Ma6



A = 24 mm, B = 12 mm

TEXI 4036

A = 36 mm, B = 18 mm

TEXI 4037

A = 50 mm, B = 25 mm

TEXI 4038



TEXI 4020

Szyft do czyszczenia stóp
żelazek suchych i parowych



CENA I INFO
www.strima.com/i4Laq

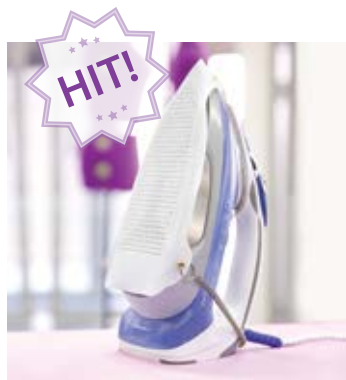

TEXI 4001

Nakładka
przeciwpołyskowa



CENA I INFO
www.strima.com/i4LaW



w aplikatorze

TEXI 4002

Proszek termoprzylepny
do podklejania
brzegów materiału



CENA I INFO
www.strima.com/i4LaX

texi. Craft Maty podkładowe i linijki

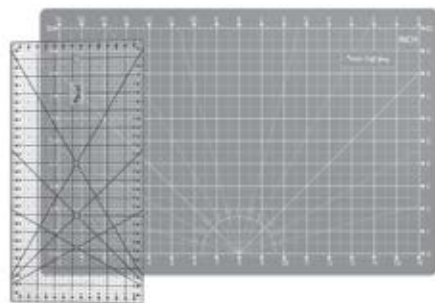

TEXI CRAFT GRAY 45X30

Komplet narzędzi do cięcia - nóż krążkowy z zapasowymi ostrzami, mata samoregenerująca (5-warstwowa, nóż rzemieślniczy z dodatkowymi ostrzami, klipsy oraz naklejki antypoślizgowe.



CENA I INFO
www.strima.com/i4VKc

Zestawy w różnych kolorach



TEXI CRAFT
PINK 60 X 45 SET

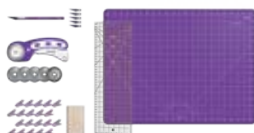

TEXI CRAFT
PURPLE 60 X 45 SET

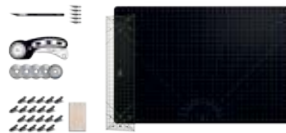

TEXI CRAFT
BLACK 90 X 60 SET

Linijki do patchworku i quiltingu

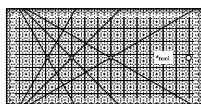

15 x 30 cm, czarny

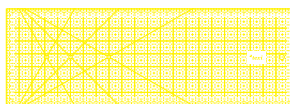

15 x 45 cm, żółty

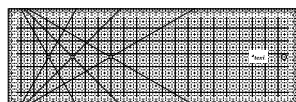

15 x 45 cm, czarny

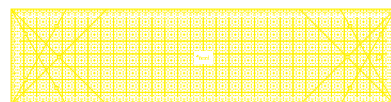

15 x 60 cm, żółty



Klipsy do szycia
38 x 11 x 15 mm
różne kolory

TEXI 4097

20 szt.



CENA I INFO

www.strima.com/i4UI3



TEXI 4106

Nóż krążkowy
Ø 45 mm



CENA I INFO

www.strima.com/i4UI3

TEXI 4107

Nóż kraft



CENA I INFO

www.strima.com/i4UI3

Jakie ostrze potrzebne?
Proste, ząbkowane, faliste?

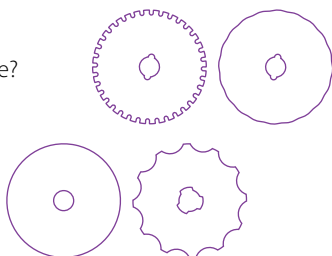

CENA I INFO

www.strima.com/s1030

Maty podkładowe

TEXI GRAY

45 x 30 cm
60 x 45 cm
90 x 60 cm

TEXI BLUE

45 x 30 cm
60 x 45 cm
90 x 60 cm

TEXI PINK

45 x 30 cm
60 x 45 cm
90 x 60 cm

TEXI BLACK

45 x 30 cm
60 x 45 cm
90 x 60 cm



CENA I INFO

www.strima.com/s1022



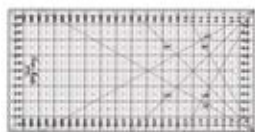

TEXI 4065

Liniał do quiltingu,
patchworku, 160x320 mm,
podziałka cm, czarna



CENA I INFO

www.strima.com/i4Nfm

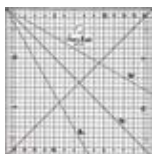

TEXI 4066

Liniał do quiltingu,
patchworku, 160x160 mm,
podziałka cm, czarna



CENA I INFO

www.strima.com/i4Nfm



TEXI 4067

Liniał do quiltingu,
patchworku, 160x320 mm,
podziałka cm, żółta



CENA I INFO

www.strima.com/i4Nfo



TEXI 4068

Uchwyt do liniałów,
podwójny



CENA I INFO

www.strima.com/i4Nfq



TEXI 4069

Uchwyt do liniałów,
pojedynczy



CENA I INFO

www.strima.com/i4Nfq



TEXI 4007

Miara krawiecka
z podziałką centymetrową,
dł. 150 cm, szer. 19 mm



CENA I INFO

www.strima.com/i4Lac



TEXI 4008

Miara krawiecka
zwijana automatycznie,
dwustronna 150 cm



CENA I INFO

www.strima.com/i4Lae



CENA I INFO
www.strima.com/s1023



texi Noże krążkowe



TEXI 4050

Ø 18 mm



TEXI 4051

Ø 28 mm



TEXI 4052

Ø 45 mm



TEXI 4053

Ø 45 mm



TEXI 4054

Ø 60 mm

Ostrza do noży



proste



skokowe



faliste

Ø 18 mm	Ø 28 mm	Ø 45 mm	Ø 60 mm
— TEXI 4055	— TEXI 4056 - - - TEXI 4058	— TEXI 4099	— TEXI 4060

texi. Prasowanie



MODEL	POWIERZCHNIA	REGULACJA WYSOKOŚCI	NAPIĘCIE	MOC ŻELAZKA	ODSYSANE	MOC TURBINY	MOC WYTWORNICY PARY	WSZYSTKO W JEDNYM PALCU	PRASULEC
TEXI BIB	40 x 120 cm	81 - 100 cm	-	-	-	-	-	-	-
TEXI CHAMPION SB	45 x 120 cm	85 - 102 cm	400 W	-	35 W	35 W	-	-	-
TEXI SMART S+B	45 x 120 cm	60 - 105 cm	200 W	800 W	40 W	40 W	1 300 W	✓	✓

TEXI SLEEVE BUCK

Prasulec rękawowy uniwersalny,
długość 52 cm



CENA I INFO
www.strima.com/i4LYq



TEXI BIB

Stół typu deska 40 x 120 cm



CENA I INFO
www.strima.com/i4TKL



Podgrzewanie Odsysanie Nadmuchi



TEXI CHAMPION SB

Stół typu deska 45 x 120 cm,
z odsysaniem, nadmuchiem i
podgrzewaną powierzchnią



CENA I INFO
www.strima.com/s1024

TEXI SMART S+B

Stół prasowniczy z automatyczną, zintegrowaną wytwornicą pary, żelazkiem i inteligentnym programowaniem czasu pracy turbiny

Podgrzewanie Odsysanie Nadmuchi

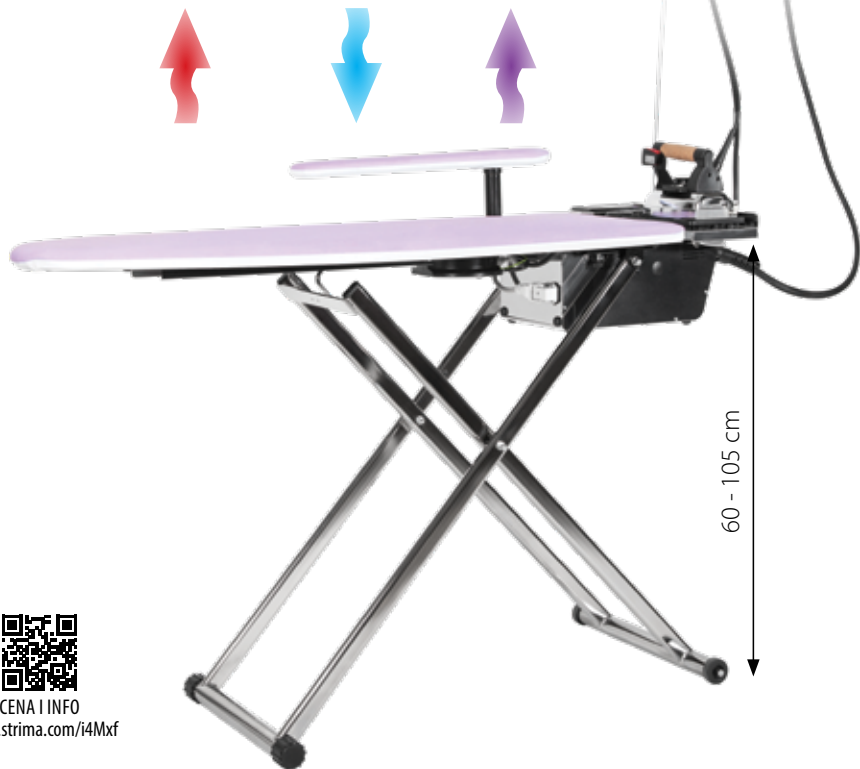

CENA I INFO
www.strima.com/i4Mxf

PAMIĘTAJ O:

TEXI 1081

TEXI SMART S+B BRUSH

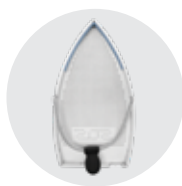

texi. Prasowalnice parowe

DOM

ATELIER

PRALNIA

HOTEL



DIGITAL CONTROL



Prasowalnica parowa sterowana elektronicznie

TEXI APOLLO 68

Powierzchnia prasowalnicza
66 x 26 cm, 1600 W

TEXI APOLLO 101

Powierzchnia prasowalnicza
vv 99 x 29 cm, 2200 W



CENA I INFO

www.strima.com/s1025

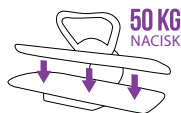

APOLLO 101

=

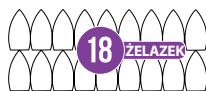

TEXI AP01

Podstawa do prasowalnic Apollo,
wysokość 93 cm



CENA I INFO

www.strima.com/i403Y



TEXI AP02

Podstawa do prasowalnic Apollo
teleskopowa
wysokość regulowana 63 - 73 cm



CENA I INFO

www.strima.com/i403Z

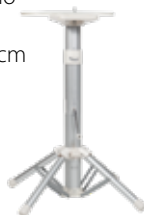



UWAGA PREMIERA

Parowiec wysokociśnieniowy

TEXI BLACK TURBO



TEXI 75S TAG GUN

Pistolet do etykietowania – standard

TEXI 75F TAG GUN

Pistolet do etykietowania z cięższą igłą do delikatnych materiałów – fine



CENA I INFO

www.strima.com/s1026



standard



fine

Igły do pistoletów



CENA I INFO

www.strima.com/s1027



TEXI 75S NEEDLE

Standard 1,85 mm



TEXI 75F NEEDLE

Fine 1,32 mm



TEXI 75S NEEDLE PREMIUM

Standard 1,85 mm



TEXI 75F NEEDLE PREMIUM

Fine 1,32 mm



CENA I INFO
www.strima.com/s1028

systemTexi75

texi

Nitki do etykietowania

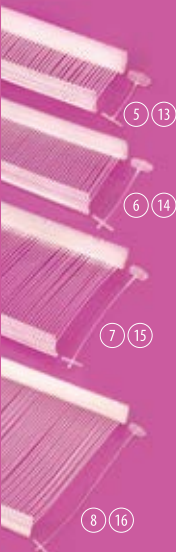

TEXI 75 PPS standard

1	TEXI 75 PPS BLACK 015	15 mm
2	TEXI 75 PPS BLACK 025	25 mm
3	TEXI 75 PPS BLACK 045	45 mm
4	TEXI 75 PPS BLACK 065	65 mm
5	TEXI 75 PPS NEUTRAL 015	15 mm
6	TEXI 75 PPS NEUTRAL 025	25 mm
7	TEXI 75 PPS NEUTRAL 045	45 mm
8	TEXI 75 PPS NEUTRAL 065	65 mm

TEXI 75 PPF fine

9	TEXI 75 PPF BLACK 015	15 mm
10	TEXI 75 PPF BLACK 025	25 mm
11	TEXI 75 PPF BLACK 045	45 mm
12	TEXI 75 PPF BLACK 065	65 mm
13	TEXI 75 PPF NEUTRAL 015	15 mm
14	TEXI 75 PPF NEUTRAL 025	25 mm
15	TEXI 75 PPF NEUTRAL 045	45 mm
16	TEXI 75 PPF NEUTRAL 065	65 mm

Nitki do ręcznego etykietowania

TEXI 75 PP SECUR LOOP 130

TEXI 75 PP SECUR LOOP 230



Strima Centrala

Swadzim k/Poznania
ul. Poznańska 54
62-080 Tarnowo Podgórne
tel. 61 8950 950
shop@strima.com

Strima Oddział
ul. Morgowa 7
91-223 Łódź
lodz@strima.com
tel. 42 662 0 555

www.strima.com

POZNAJ NAS

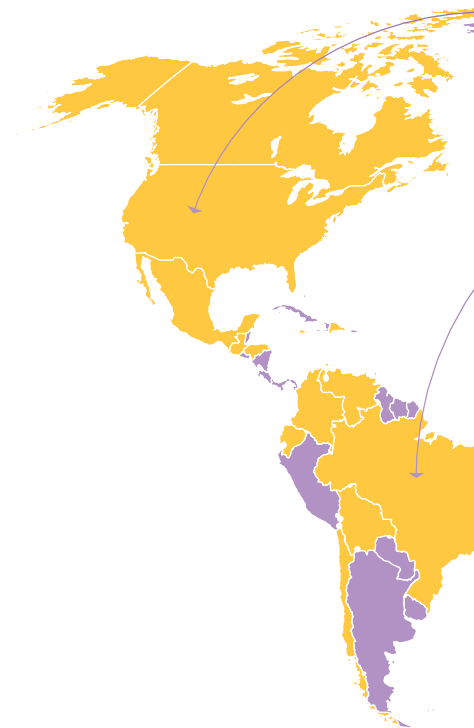

ZAOPATRZONY
MAGAZYN



Światowy dystrybutor *texi*[®]

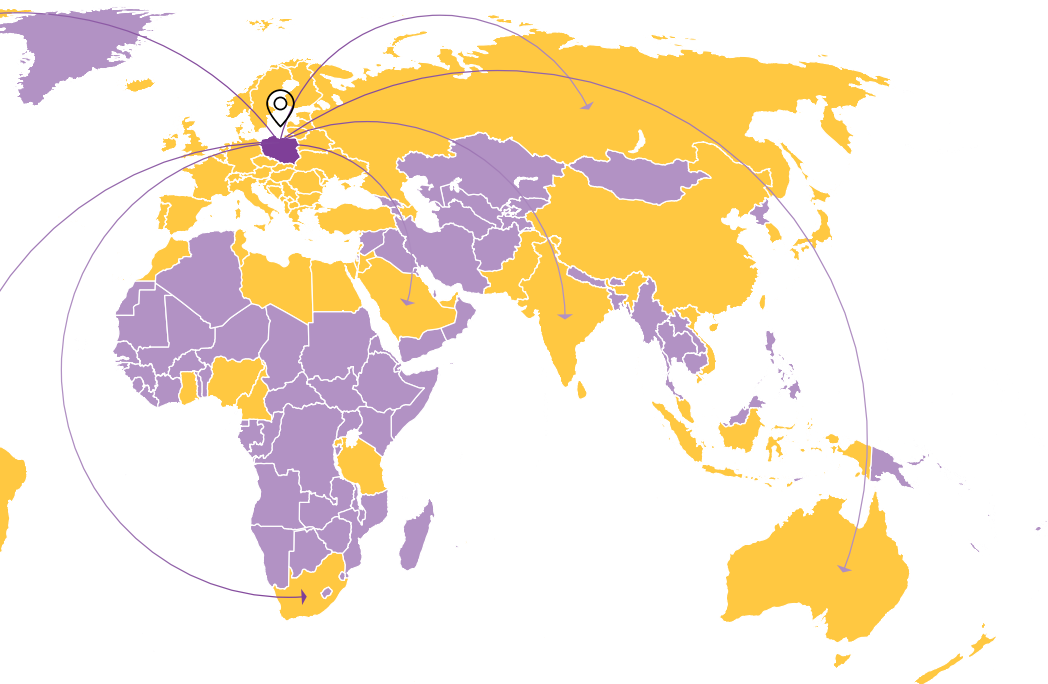

SZYBKA
DOSTAWA



WSPARCIE
TECHNICZNE



Dystrybucja

www.strima.com